



Nova 1

Side Table

nomon
JEWELRY FOR HOME

MATERIALES

MATERIALS

Chapado nogal o roble natural. Fabricado y pulido a mano.
Natural walnut or oak veneered wood. Manufactured and polished by hand.



OPCIONES MADERA

WOOD OPTIONS



Nogal
Walnut



Fresno negro
Black Ash



Roble
Oak

OPCIONES METAL

METAL OPTIONS



Brass finish
Acabado latón

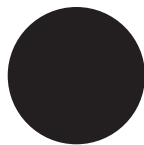

Black finish
Acabado negro

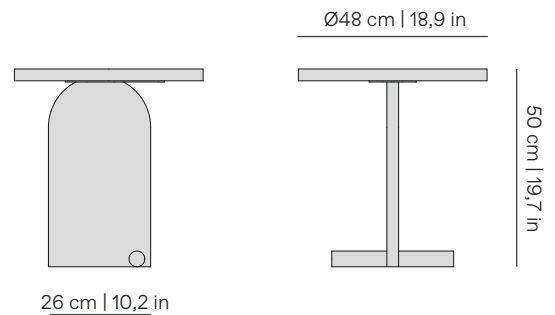

PACKAGING

Peso: 11 kg
Dimensiones (cm): 53x53x13cm | 20.9x20.9x5.1in
Peso volumétrico: 7,3 kg

Weight: 11 kg
Dimensions (cm): 53x53x13cm | 20.9x20.9x5.1in
Volumetric weight L: 7,3 kg

Nova 2

Side Table

nomon
JEWELRY FOR HOME

MATERIALES

MATERIALS

Chapado nogal o roble natural. Fabricado y pulido a mano.
Natural walnut or oak veneered wood. Manufactured and polished by hand.



OPCIONES MADERA

WOOD OPTIONS



Nogal
Walnut



Fresno negro
Black Ash



Roble
Oak

OPCIONES METAL

METAL OPTIONS



Brass finish
Acabado latón



Black finish
Acabado negro

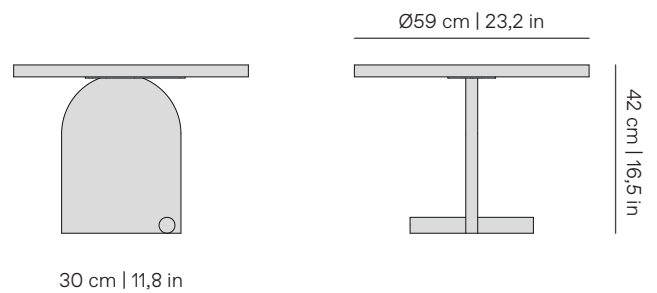

PACKAGING

Peso: 13 kg
Dimensiones (cm): 64x64x13cm | 25.2x25.2x5.1in
Peso volumétrico: 10,6 kg

Weight: 13 kg
Dimensions (cm): 64x64x13cm | 25.2x25.2x5.1in
Volumetric weight L: 10,6 kg

Nova 3

Coffee Table

nomon
JEWELRY FOR HOME

MATERIALES

MATERIALS

Chapado nogal o roble natural. Fabricado y pulido a mano.

Natural walnut or oak veneered wood. Manufactured and polished by hand.

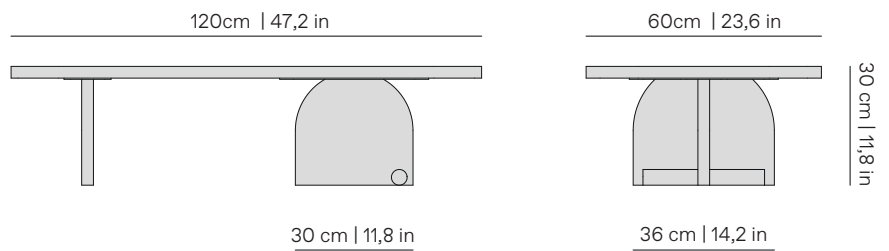

OPCIONES MADERA

WOOD OPTIONS



Nogal
Walnut



Fresno negro
Black Ash



Roble
Oak



Brass finish
Acabado latón

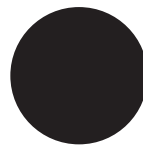

Black finish
Acabado negro

OPCIONES METAL

METAL OPTIONS

PACKAGING

Peso: 24 kg

Dimensiones (cm): 125x65x13cm | 49.2x25.6x5.1in

Peso volumétrico: 21,1 kg

Weight: 24 kg

Dimensions (cm): 125x65x13cm | 49.2x25.6x5.1in

Volumetric weight L: 21,1 kg

Nova 4

Coffee Table

nomon
JEWELRY FOR HOME

MATERIALES

MATERIALS

Chapado nogal o roble natural. Fabricado y pulido a mano.

Natural walnut or oak veneered wood. Manufactured and polished by hand.

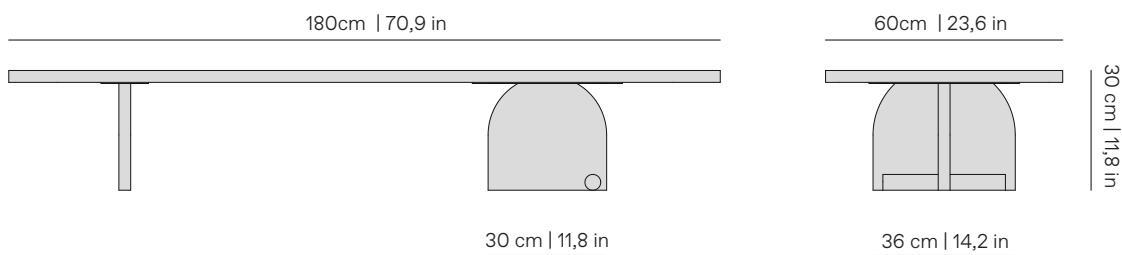

OPCIONES MADERA

WOOD OPTIONS



Nogal
Walnut



Fresno negro
Black Ash



Roble
Oak



Brass finish
Acabado latón

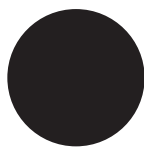

Black finish
Acabado negro

OPCIONES METAL

METAL OPTIONS

PACKAGING

Peso: 33 kg

Dimensiones (cm): 185x65x13cm | 72.8x25.6x5.1in

Peso volumétrico: 31,2 kg

Weight: 33 kg

Dimensions (cm): 185x65x13cm | 72.8x25.6x5.1in

Volumetric weight L: 31,2 kg